

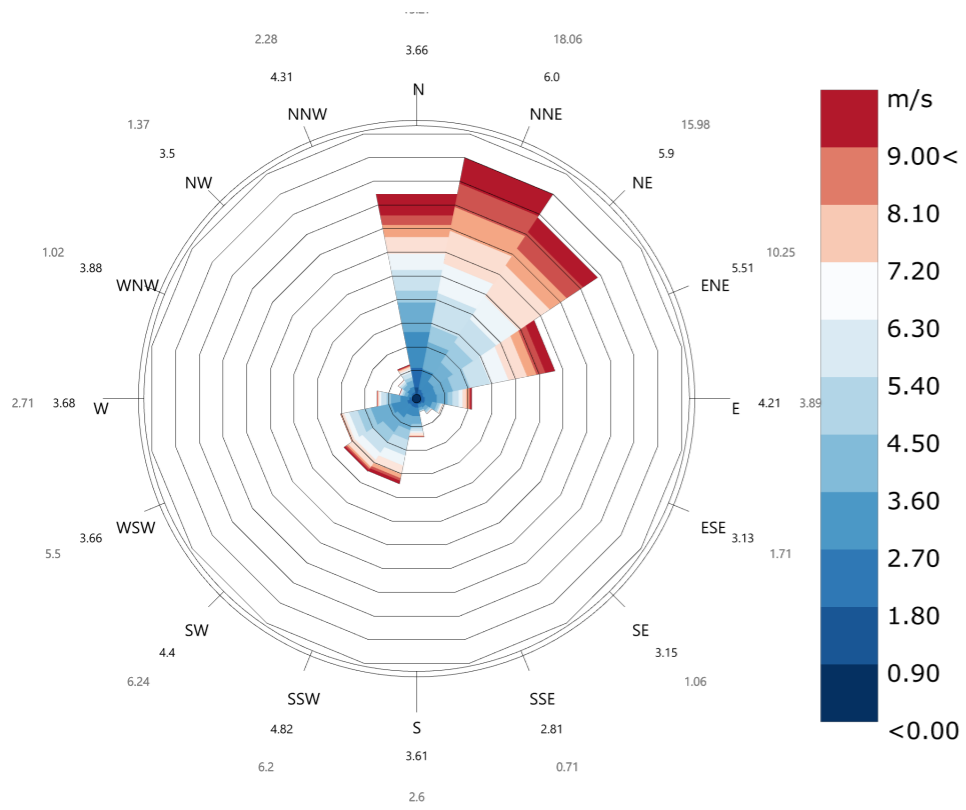

GÜNEŞ VE HAKİM RÜZGAR YÖNÜ



Wind-Rose
 ISTANBUL_TUR
 1 JAN 1:00 - 31 DEC 24:00
 Hourly Data: Wind Speed (m/s)
 Calm for 5.14% of the time = 450 hours.
 Each closed polyline shows frequency of 1.8%. = 158 hours.

RÜZGAR ANALİZİ

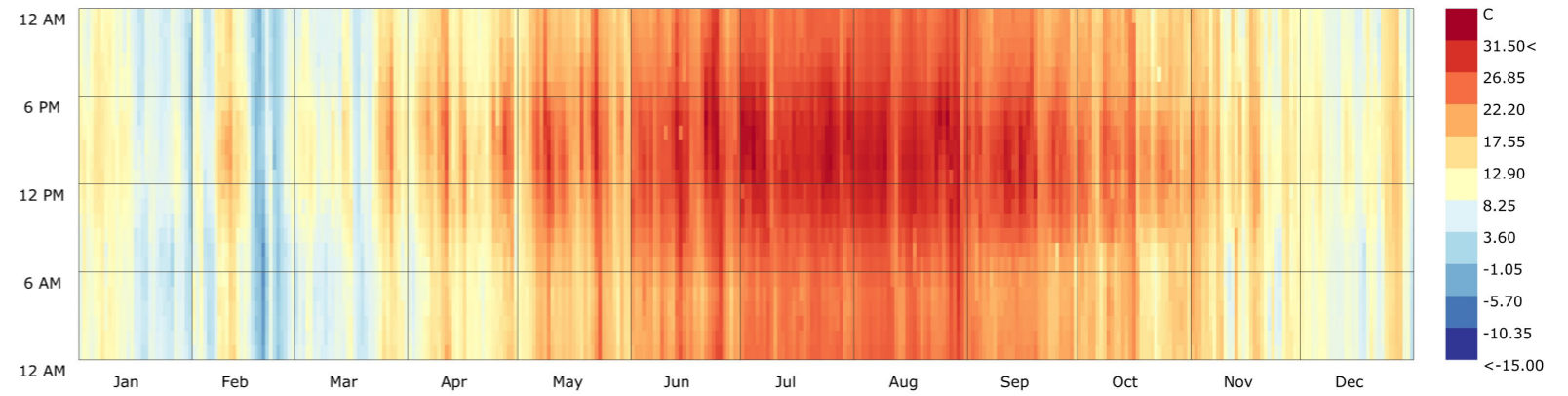

Dry Bulb Temperature (C) - Hourly
 ISTANBUL_TUR
 1 JAN 1:00 - 31 DEC 24:00

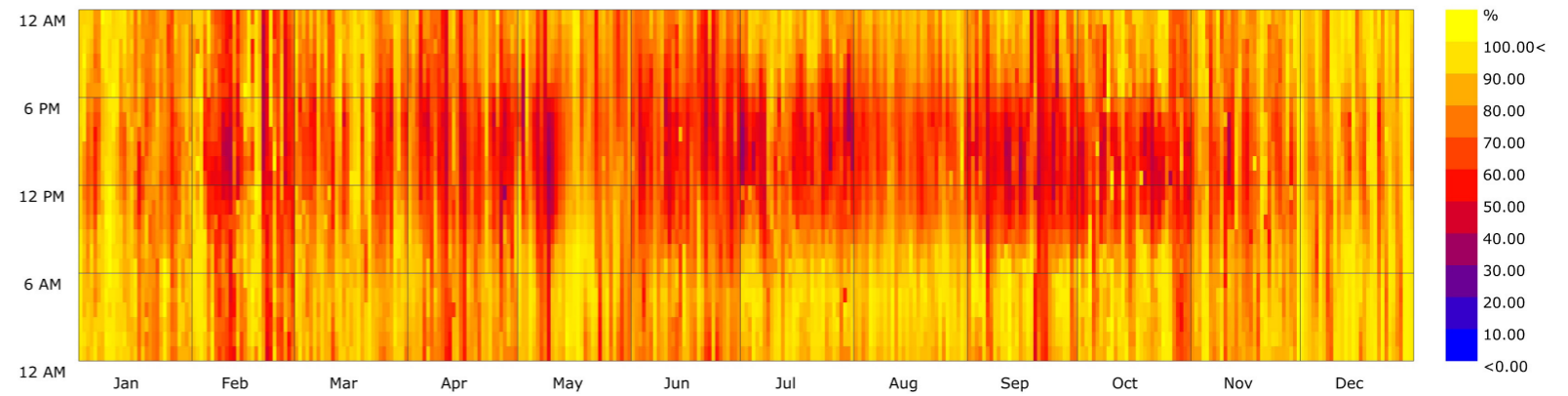

Relative Humidity (%) - Hourly
 ISTANBUL_TUR
 1 JAN 1:00 - 31 DEC 24:00

NEM VE ISI ANALİZİ

ARSA SINIRLARI

İNŞAAT ALANI

B4-B3-B2 KATLARI : $1202,63 \times 3 = 3607,89 \text{ m}^2$

B1: 491,81 m²

ZK: 497,76 m²

TİP KATLAR: $364,36 \times 9 = 3279,24 \text{ m}^2$

ÇATI KATI: 211,29 m²

TOPLAM: 8087,99 m²

GİRİŞ

HASGÜL SOKAK

5m

3m

5m

3m

ÇİM SOKAK

Raylı Toplu Taşıma Hattı

VAZİYET PLANI



İNŞAAT ALANI

B4-B3-B2 KATLARI : $1202,63 \times 3 = 3607,89 \text{ m}^2$

B1: 491,81 m^2

ZK: 497,76 m^2

TİP KATLAR: $364,36 \times 9 = 3279,24 \text{ m}^2$

ÇATI KATI: 211,29 m^2

TOPLAM: 8087,99 m^2

KÜTLE DİYAGRAMLARI

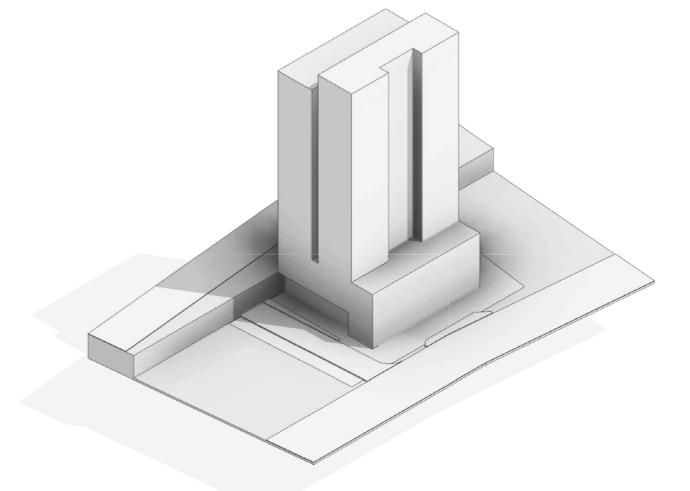
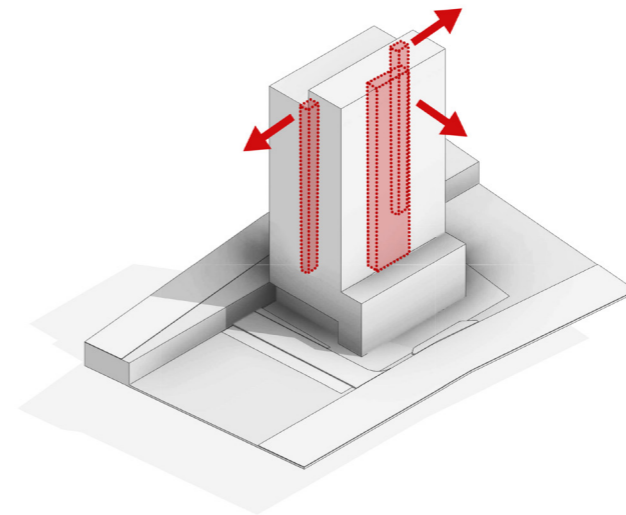
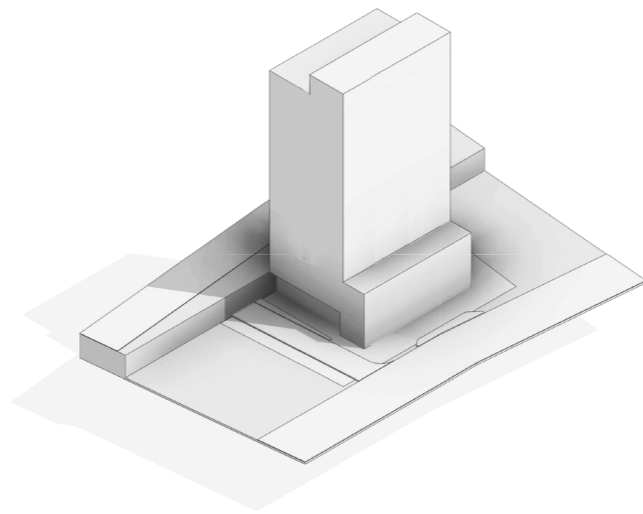
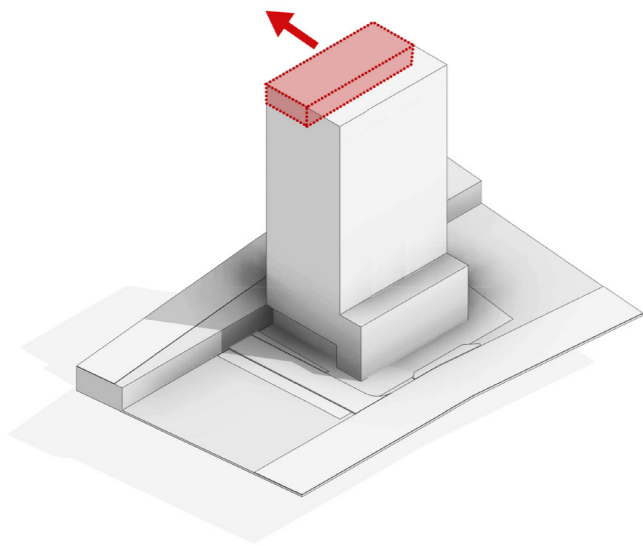
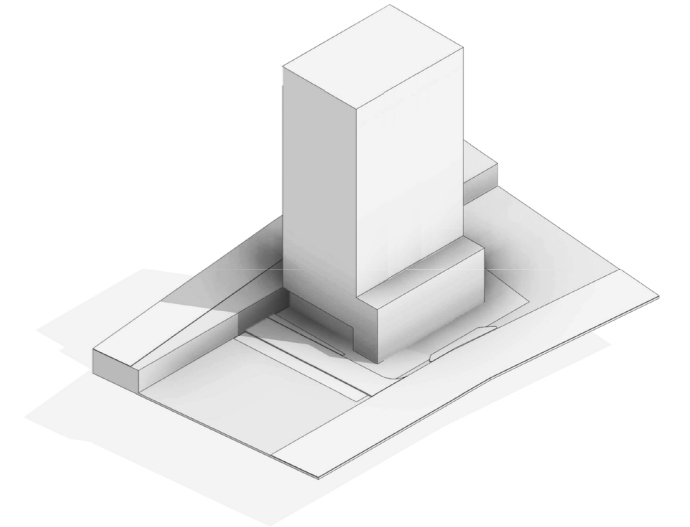
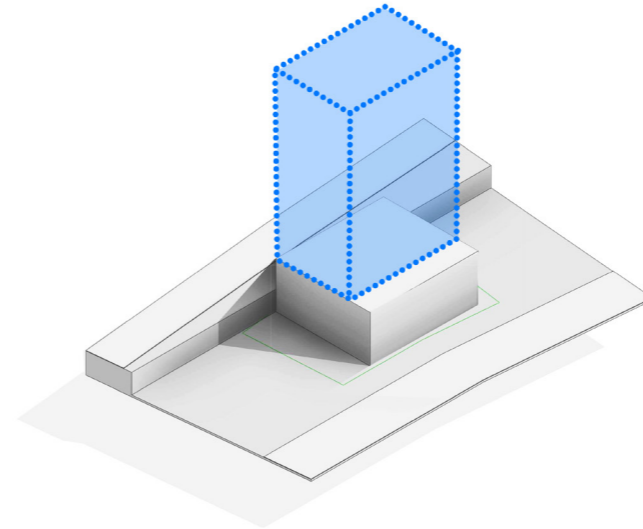
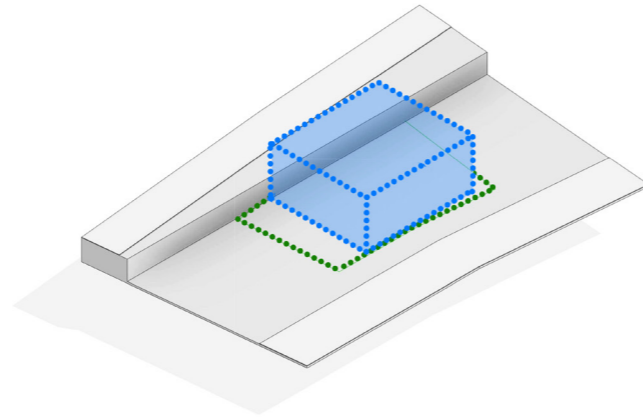
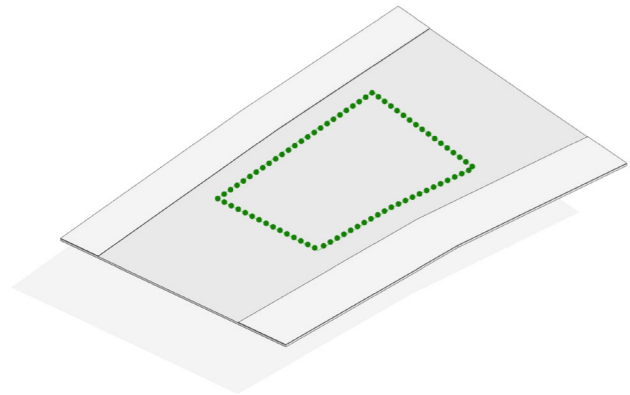

KÜTLE DİYAGRAMLARI

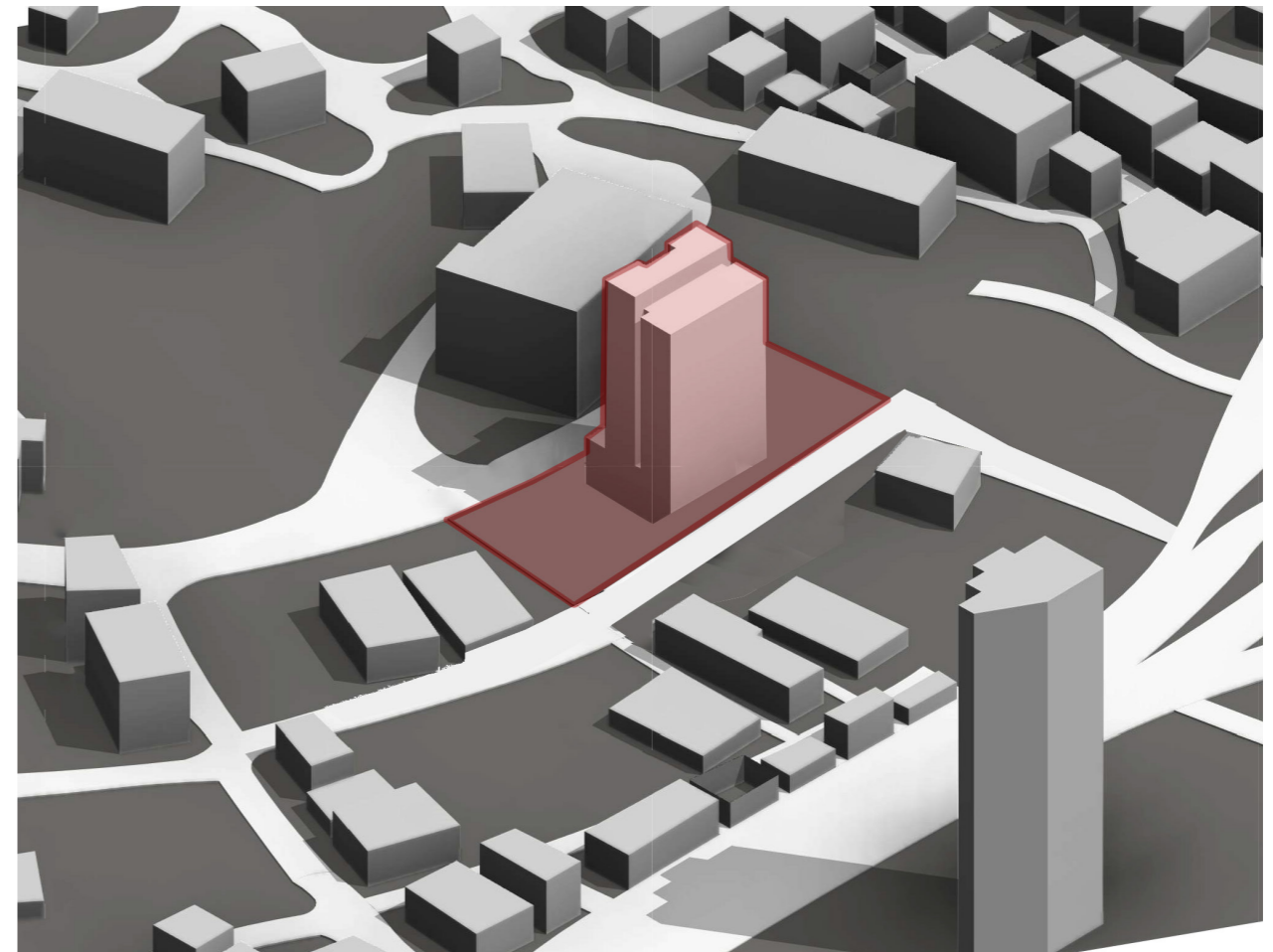
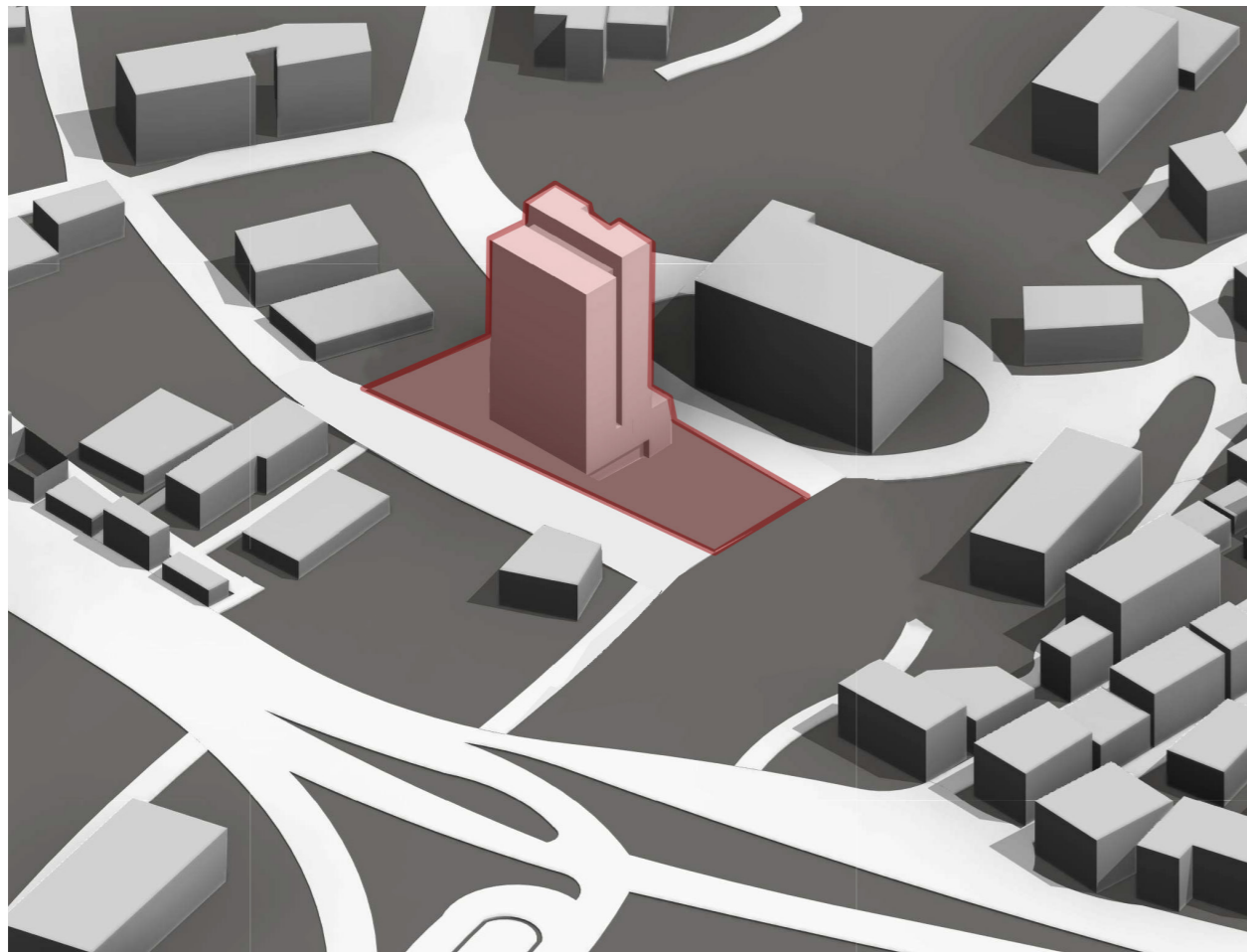
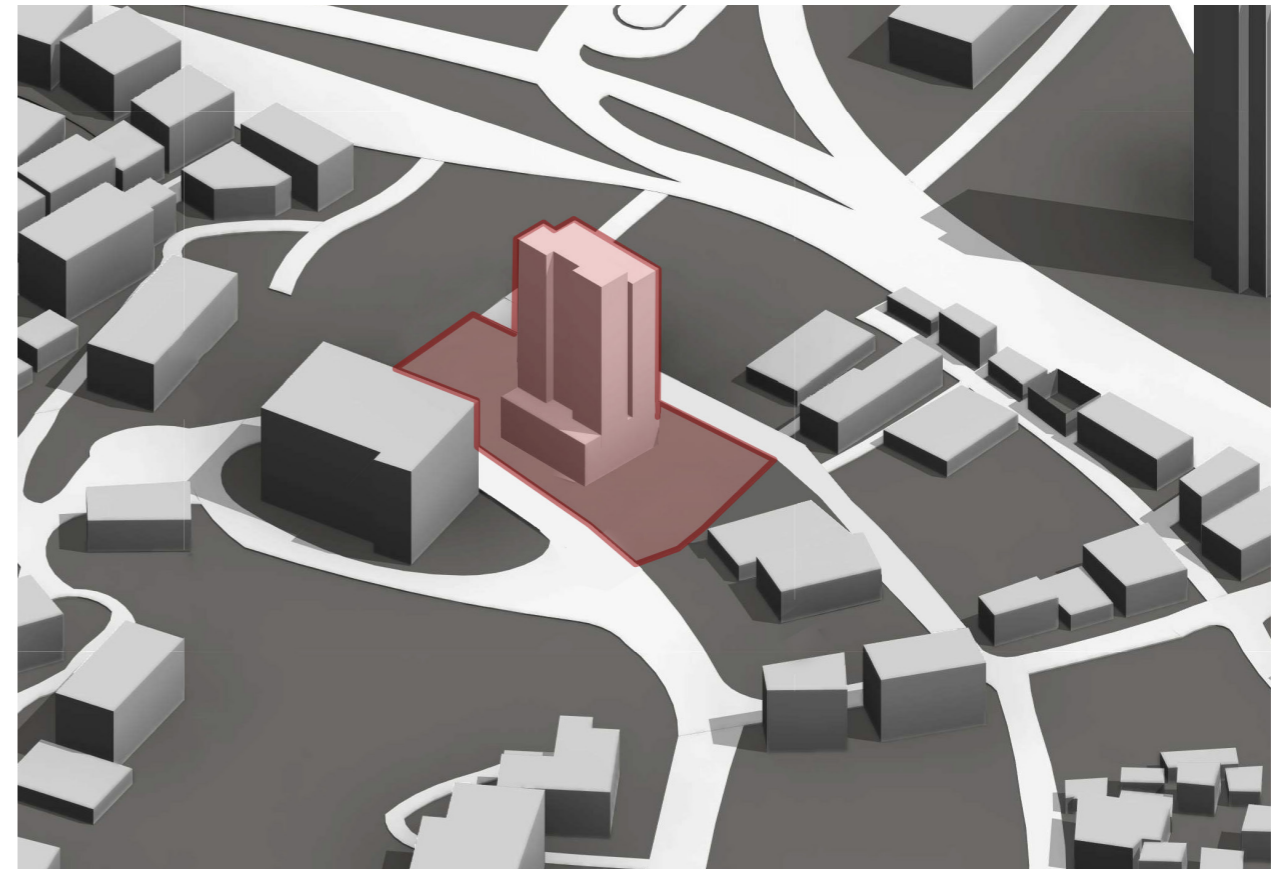
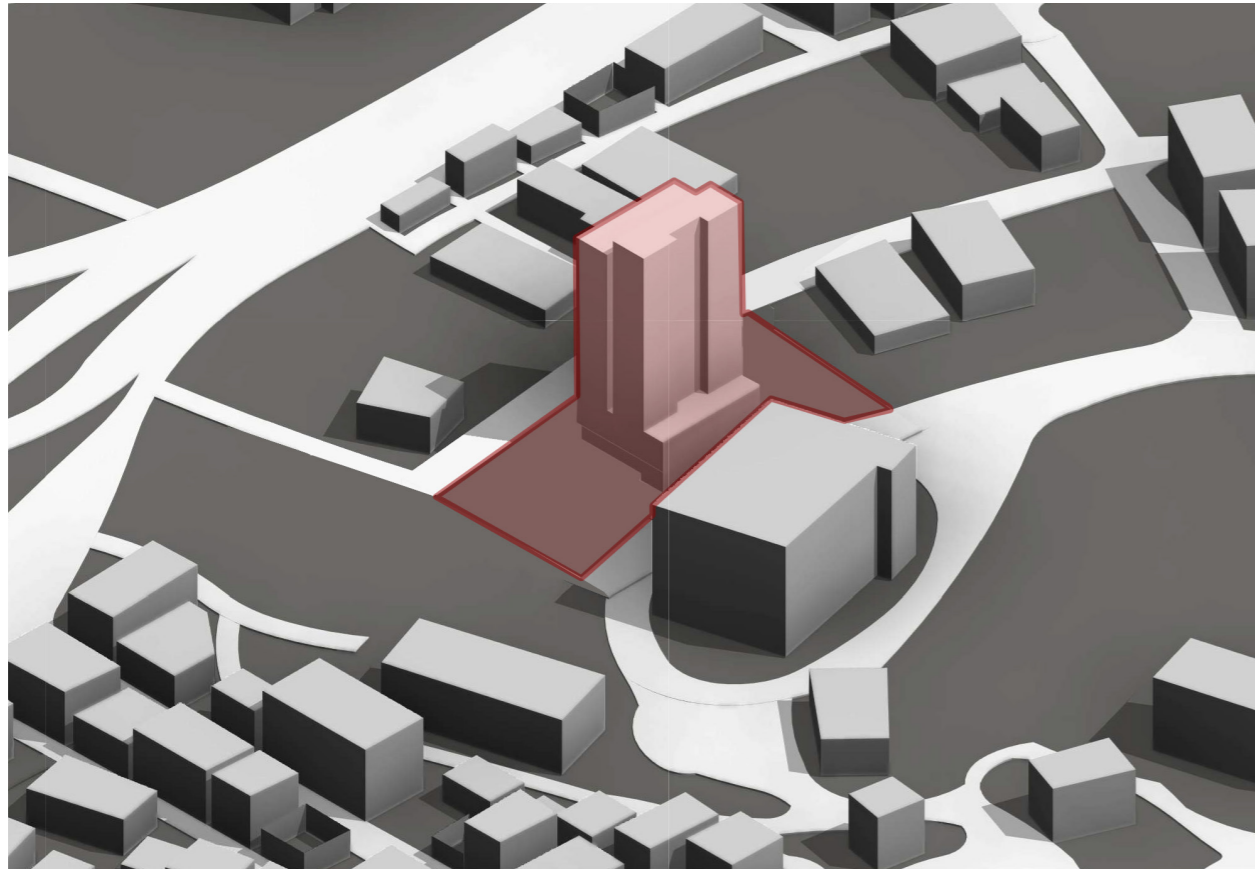

FONKSIYON DIYAGRAMLARI

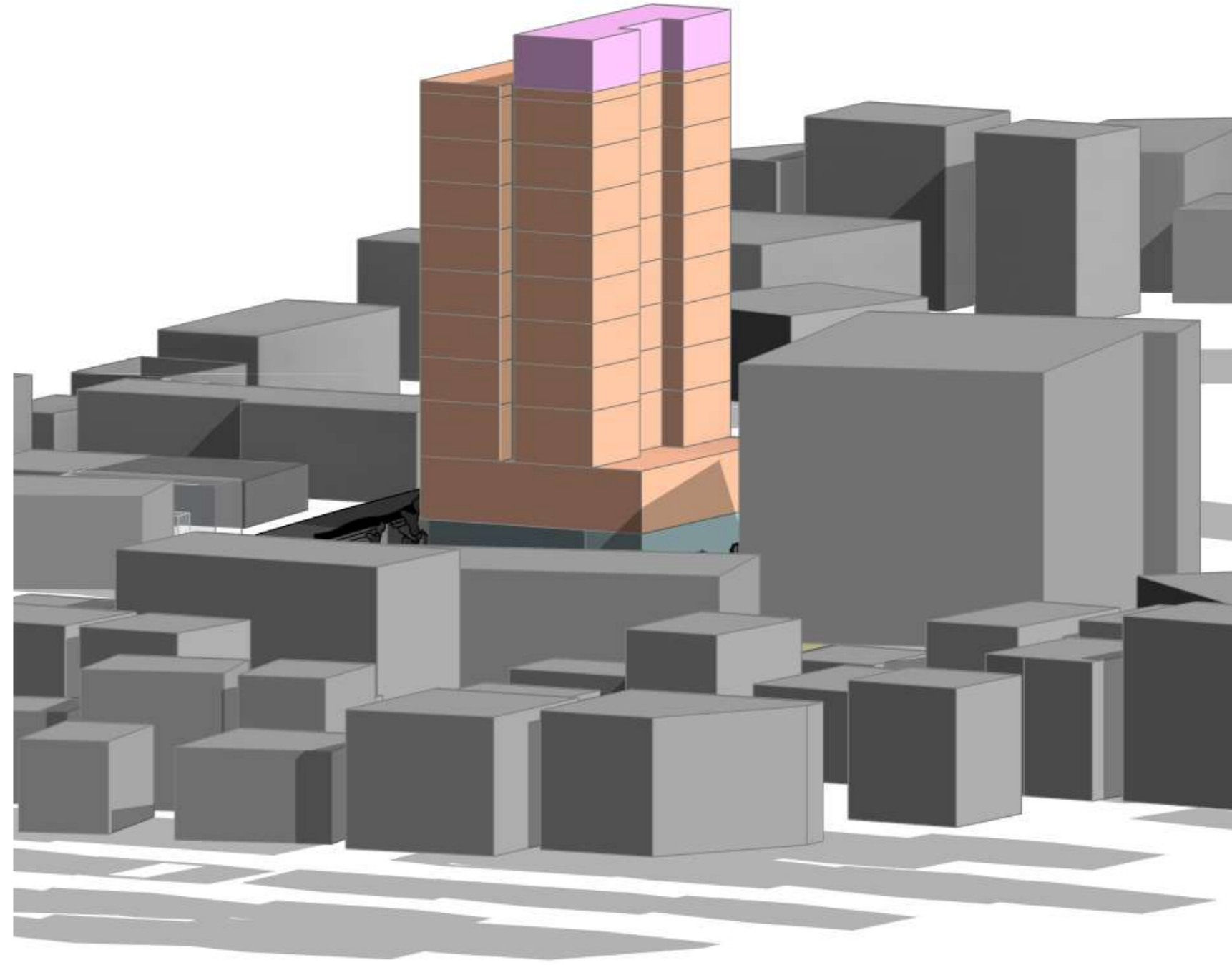
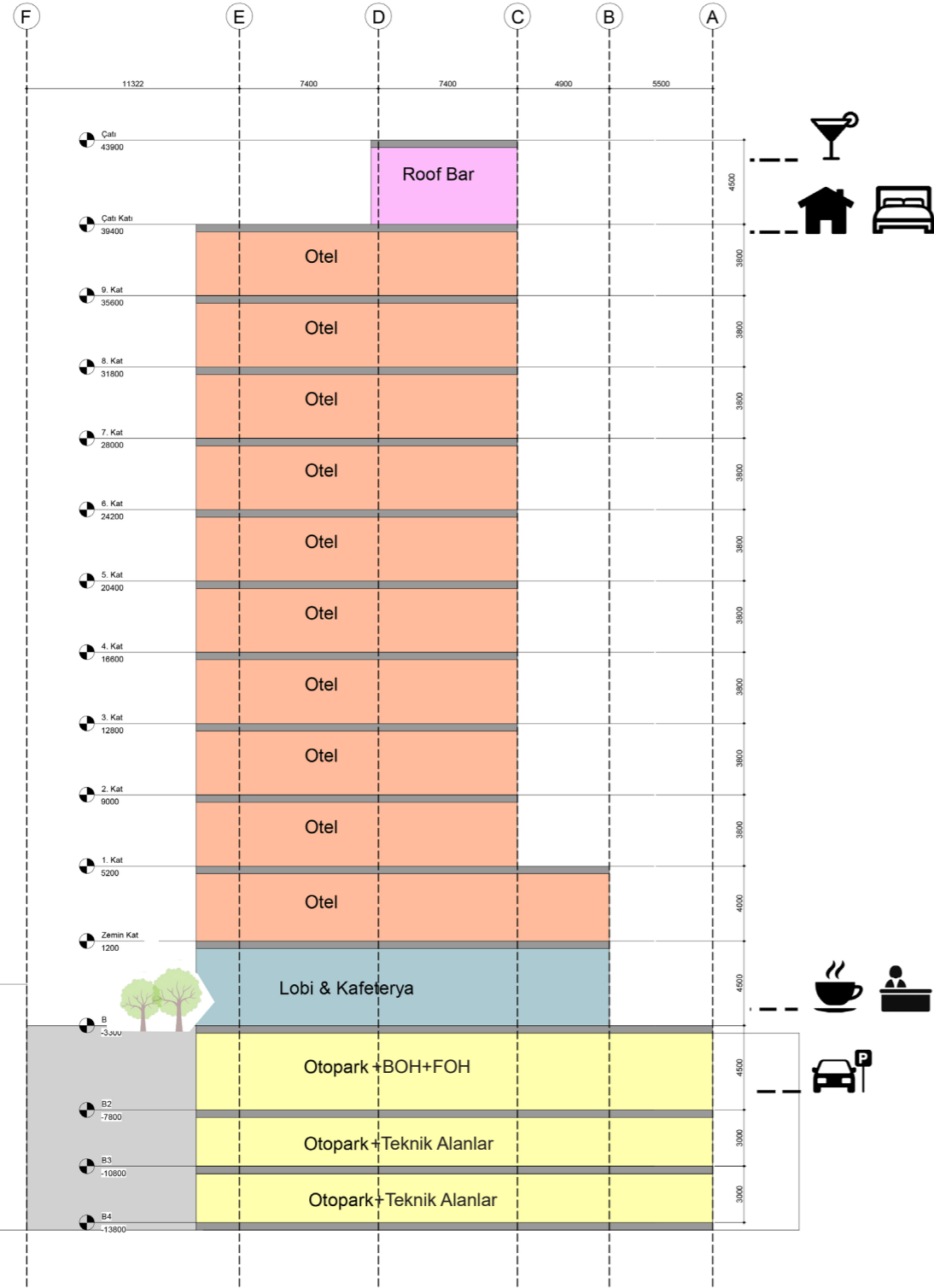



DOME+PARTNERS



DOME+PARTNERS



DOME+PARTNERS

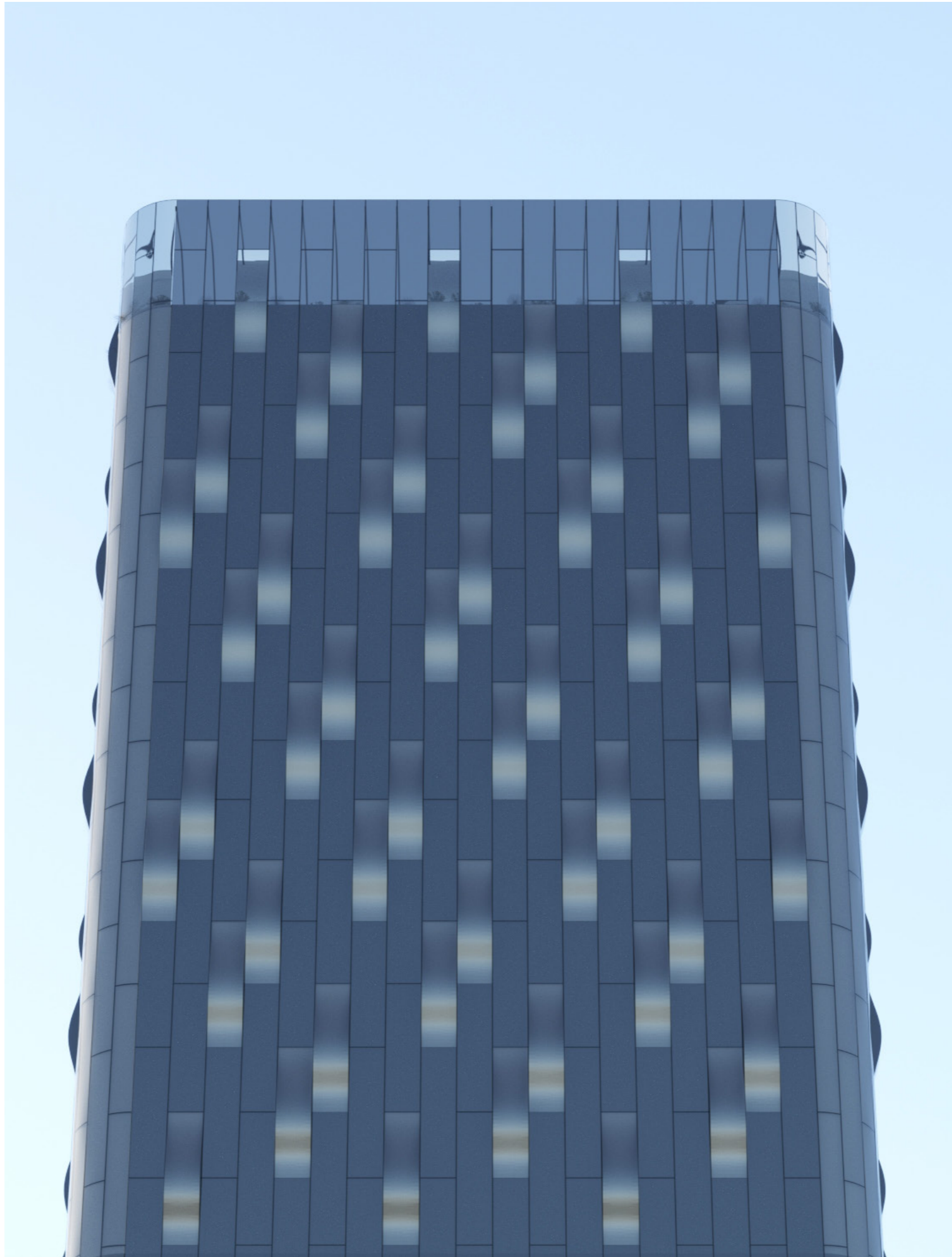



DOME+PARTNERS

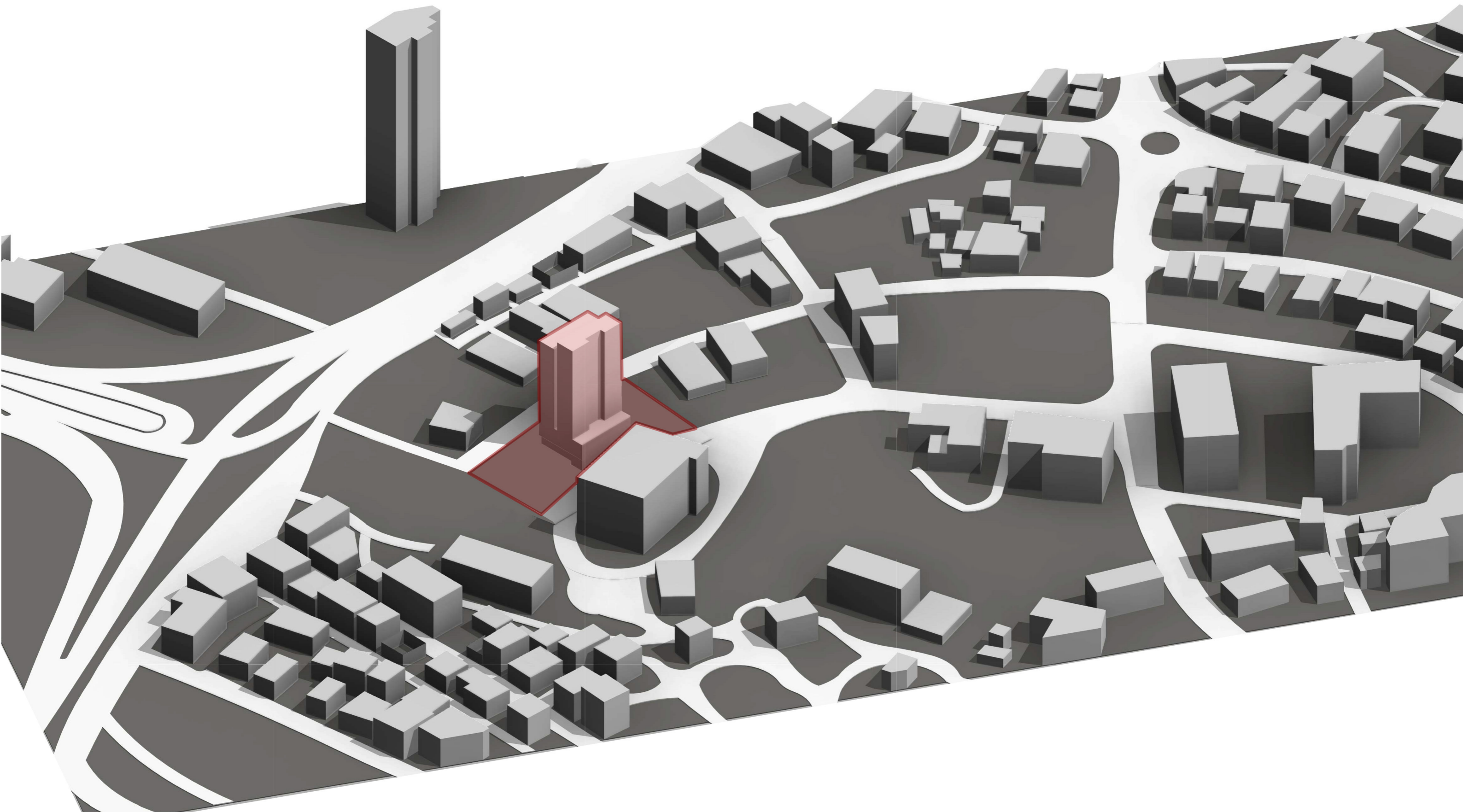

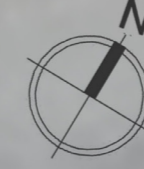

ARAZI GİRİŞİ

Hasgöl Sokağı

-2.52
+60.83

-2.65
+60.71



Mahal Lejantı

- ASANSÖR HOLLÜ
- AÇIK OTURMA ALANI
- BAVUL ODASI
- DEPO
- ERKEK WC
- GİRİŞ
- KADIN WC
- KAFETERYA
- KORIDOR
- LOBI+KAHVALTI
- MAL KABUL
- MUTFAK
- PERSONEL GİRİŞİ
- RESEPSİYON
- S. ASANSÖR HOLLÜ
- S. ASANSÖRÜ
- YANGIN GÜV. HOLLÜ
- YANGIN MERDIVENİ
- ÖN BÜRO

RAYLI TOPLU TAŞIMA HATTI

-0.23
+63.17

Yeşilçim Sokağı

-0.95
+62.40

B1 KAT PLANI



ZEMİN KAT PLANI



BİRİNCİ KAT PLANI



TIP KAT PLANI

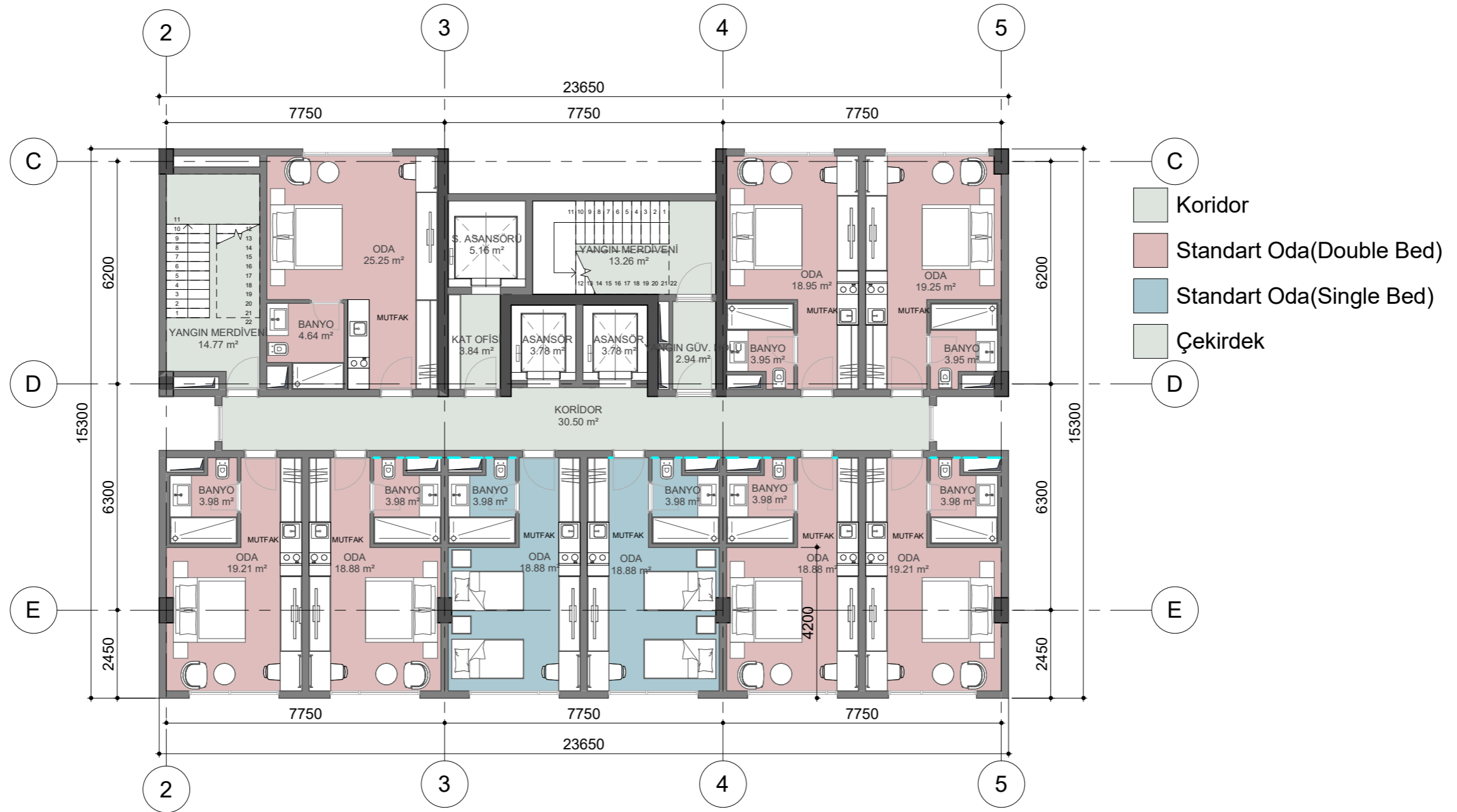

ÇATI KAT PLANI



B2 KAT PLANI



PLANLANAN İŞLEVLER:

Front of House:

- Toplantı odaları
- Fitness
- Çok Amaçlı Salon

Back of House:

- Housekeeping
- İdari ofis
- Teknik ofis

B3 KAT PLANI



PLANLANAN İŞLEVLER:

- Çamaşırhane
- Ⓒ Mutfak-Yemekhane
- Ⓓ Teknik Alanlar



A-A KESİTİ

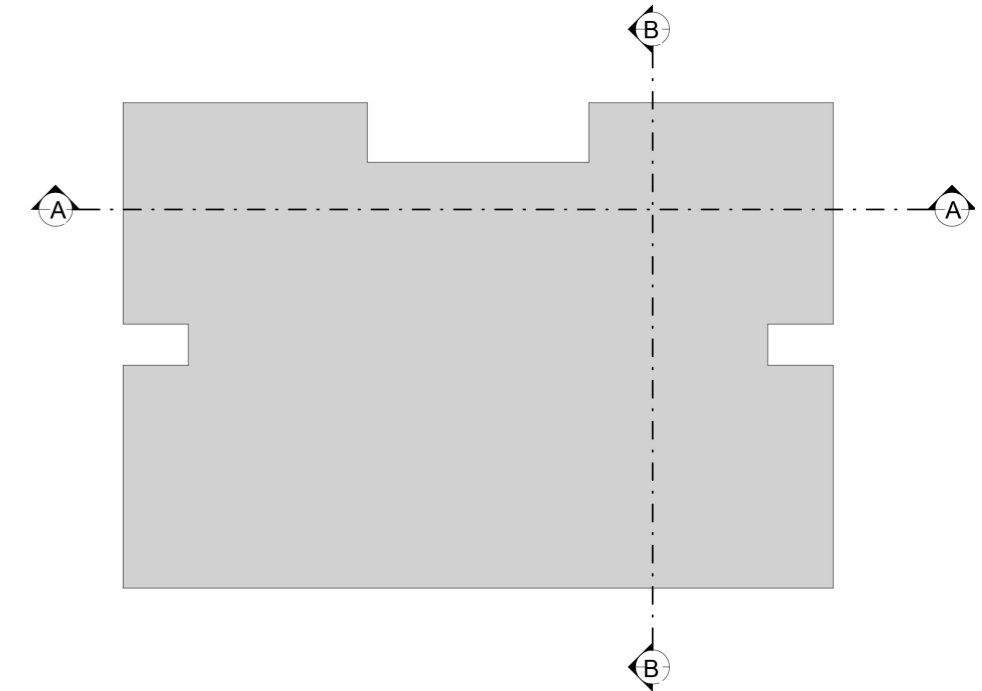
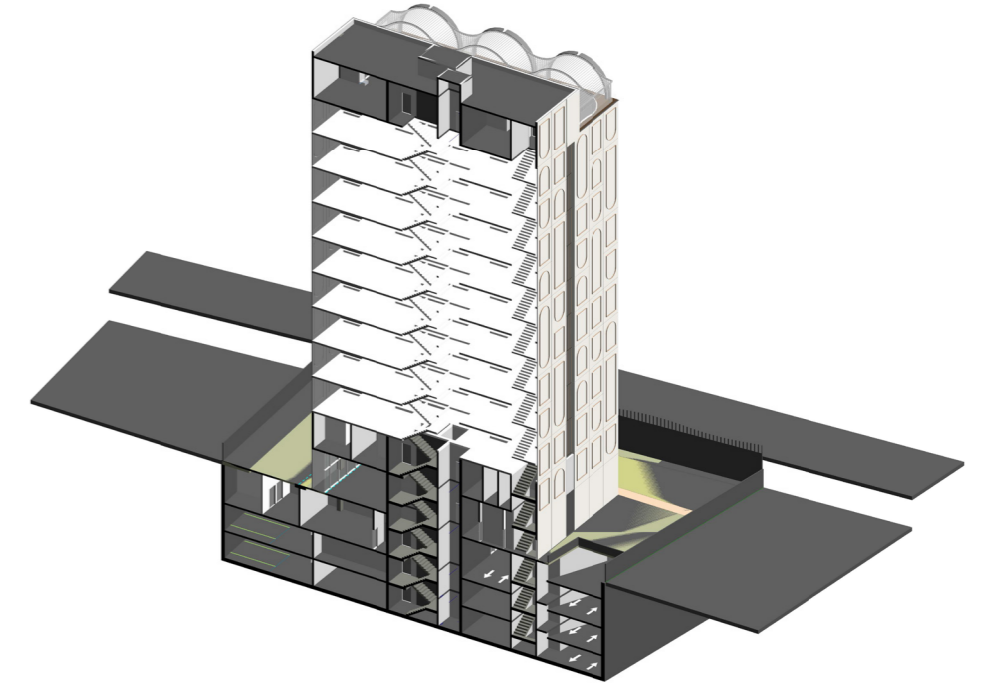
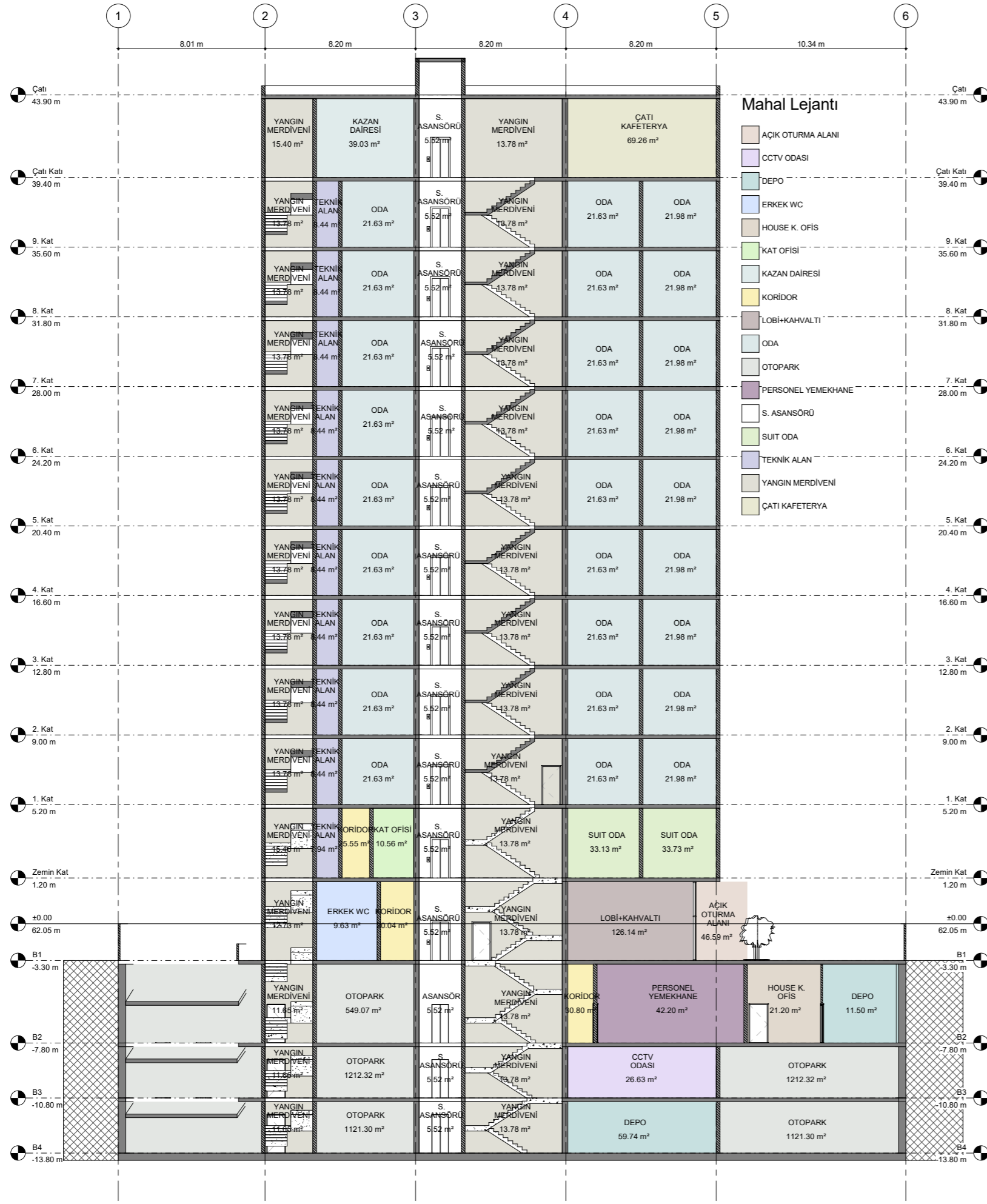

B - B KESİTİ

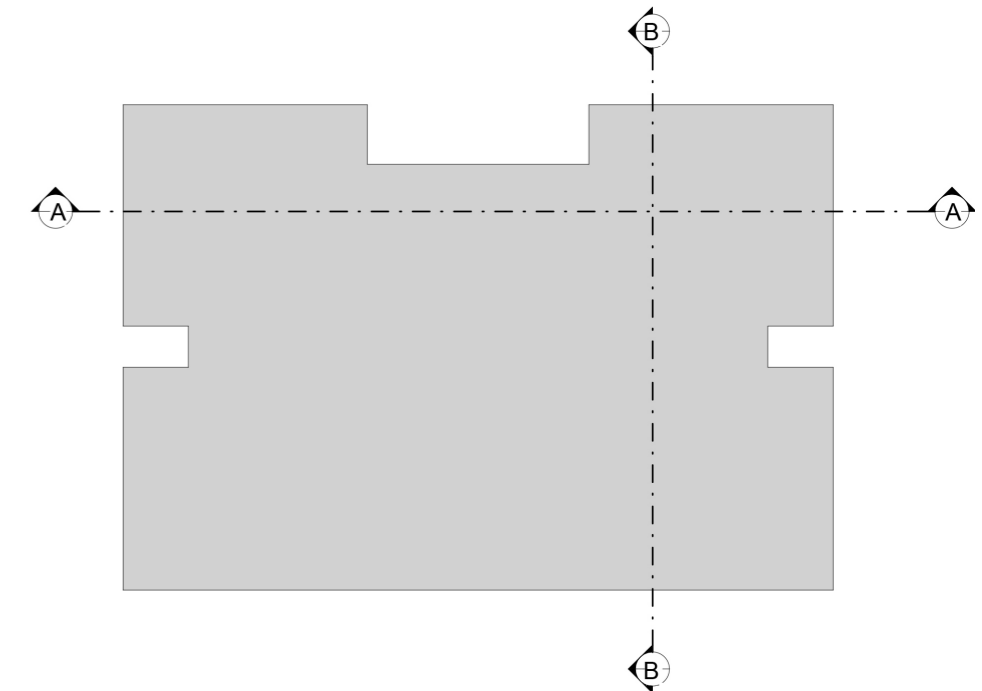
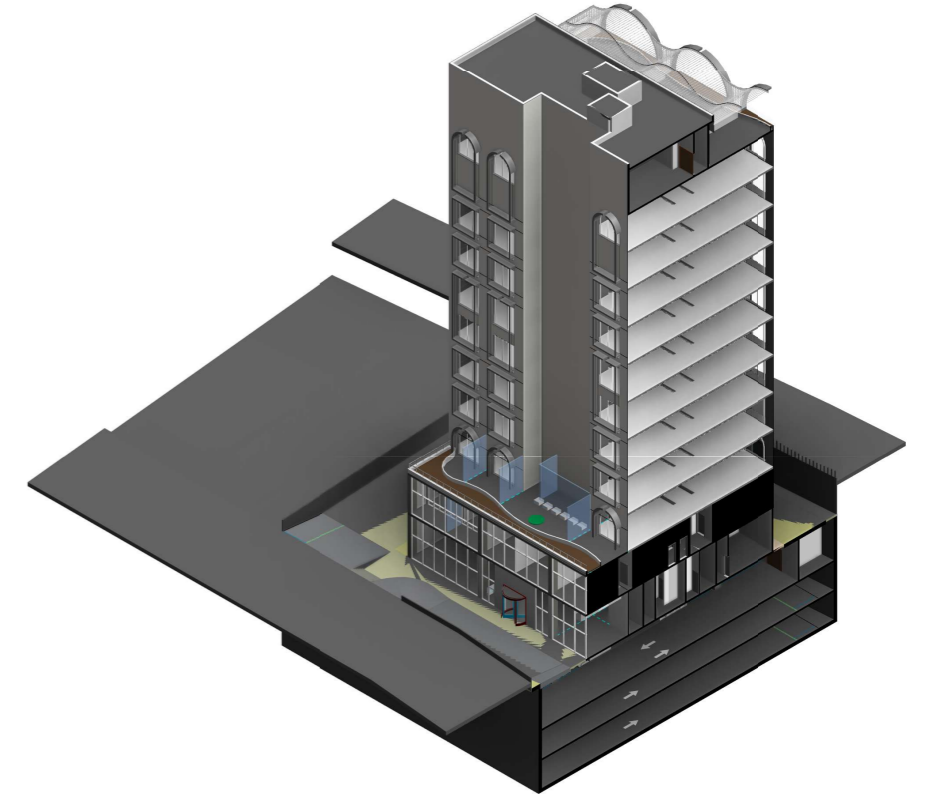
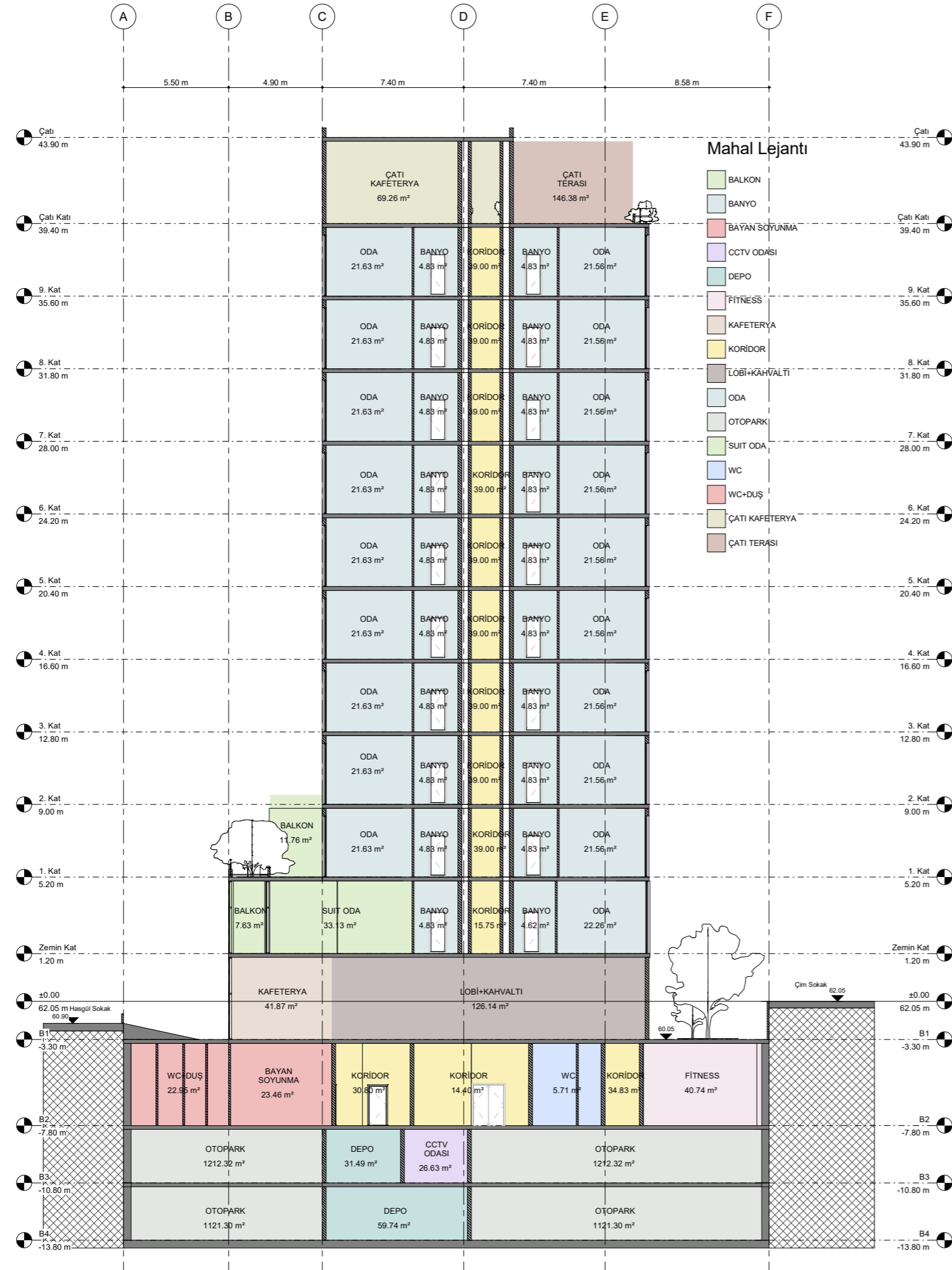

DOME+PARTNERS

